

Technical data sheet

Spacer for flat conductor, with threaded connection M6

Item number: 5032245

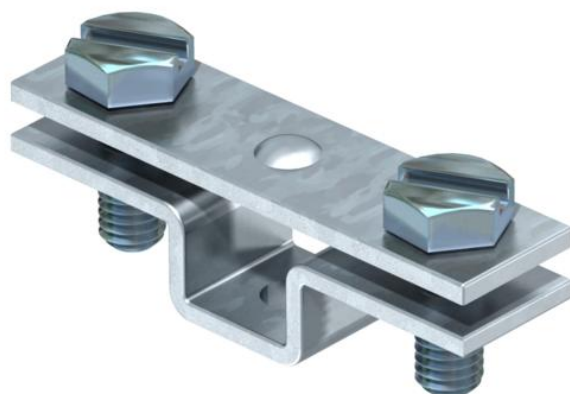

- Fit: FL 30 and FL 40
- With attaching thread M6 and 2 hexagonal bolts M6 x 16 (F)

St	Steel
FT	Hot-dip galvanised

Master data

Item number	5032245
Type	831 40 M6
Description 1	Spacer
Description 2	for steel strip
Manufacturer	OBO
Dimension	40mm
Material	Steel
Surface	Hot-dip galvanised
Surface standard	DIN EN ISO 1461
Smallest sales unit	25
Unit of quantity	Piece
Weight	3.88 kg
Weight unit	kg/100 pc.

Technical data sheet

Spacer for flat conductor, with threaded connection M6

Item number: 5032245



Dimensions

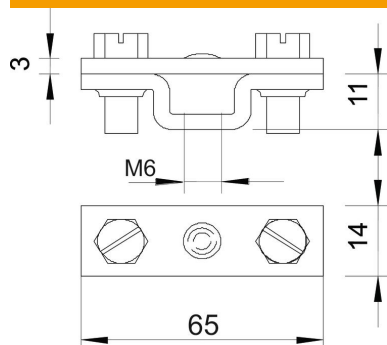

Dimension B	65 mm
-------------	-------

Technical data

Fit	max. FL40 mm
Intermediate plate	no